



8095

Wheel Loaders 0.7 - 0.95 m³



The elite among wheel loaders

The wheel loaders of the 80-series by Kramer set high standards in terms of technology, performance and comfort. Other plus points are versatility in use, optimal power to weight ratio and exceptional performance statistics.

- One-piece frame and all-wheel steering
- Hydraulic quick coupler system and parallel-controlled loading system
- Particularly spacious panoramic cab with the highest level of operator comfort
- Efficient drive and low operating costs
- Variety of options for a large range of uses



8095

Wheel Loaders 0.7 - 0.95 m³

Technical specifications

Operating data

Bucket capacity (standard bucket)	0.95 m ³
Operating weight	4,990 kg

Engine / Motor

Engine / Motor manufacturer	Deutz
Engine performance	55.4 kW

Power transmission

Travel speed (standard)	20 km/h
Travel speed (optional)	40 km/h
Differential lock	Self-locking differential
Standard tires	12.5-20

Steering and operating hydraulics

Flow rate (pump)	70 l/min
Pressure (maximum)	240 bar
Flow rate (optional)	115 l/min

Kinematics

Tipping load (with bucket)	3,750 kg
Payload (S=1.25)	2,300 kg

Additional technical data is available in the detailed brochure in the informational material section



Dimensions

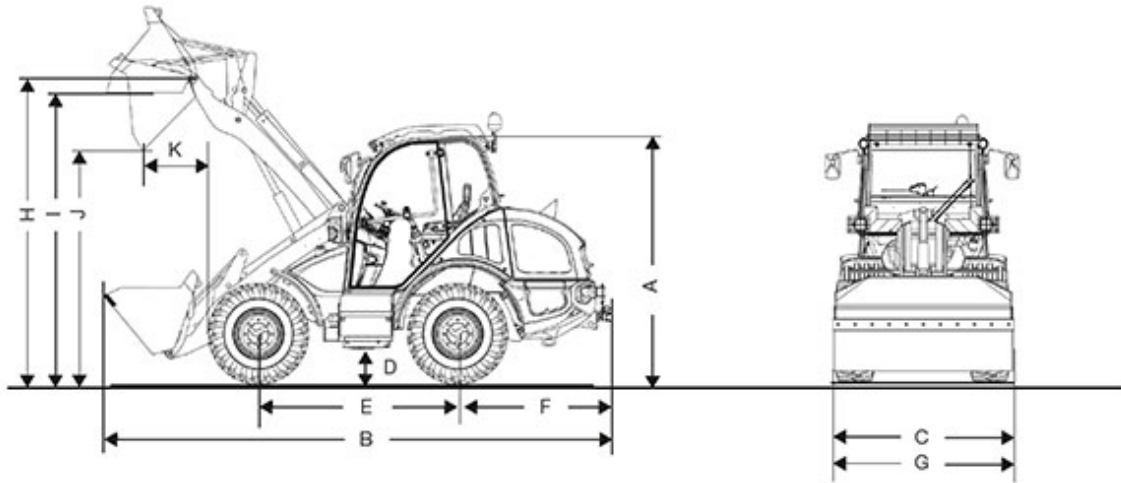

A	Height	2,480 mm
B	Length	5,410 mm
C	Width	1,720 mm
D	Ground clearance	330 mm
E	Wheelbase	2,020 mm
	Center of front axle to tip of teeth	1,900 mm
F	Center of rear axle to end of vehicle	1,490 mm
G	Bucket width	1,950 mm
H	Bucket pivot point	3,290 mm
I	Overhead loading height	3,090 mm
J	Dumping height	2,580 mm
K	Dump reach	650 mm
	Stack height	3,040 mm



Turning radius (over tyres)

2,840 mm

Information on suitable accessories can be found on our website.

The right to make changes is reserved in the interests of ongoing further developments. You can find more information on the engine power in the operator's manual. The actual power output figures may vary due to specific operating conditions.

Information on suitable accessories can be found on our website. More detailed information on engine power can be found in the operator's manual; the stated power may vary due to specific operating conditions. Subject to alterations and errors excepted. Applicable also to illustrations. Copyright © 2017 Kramer-Werke GmbH.